

4'X4' LOW BACK REFRIGERATED SLANT BIN

Critical
TEMP

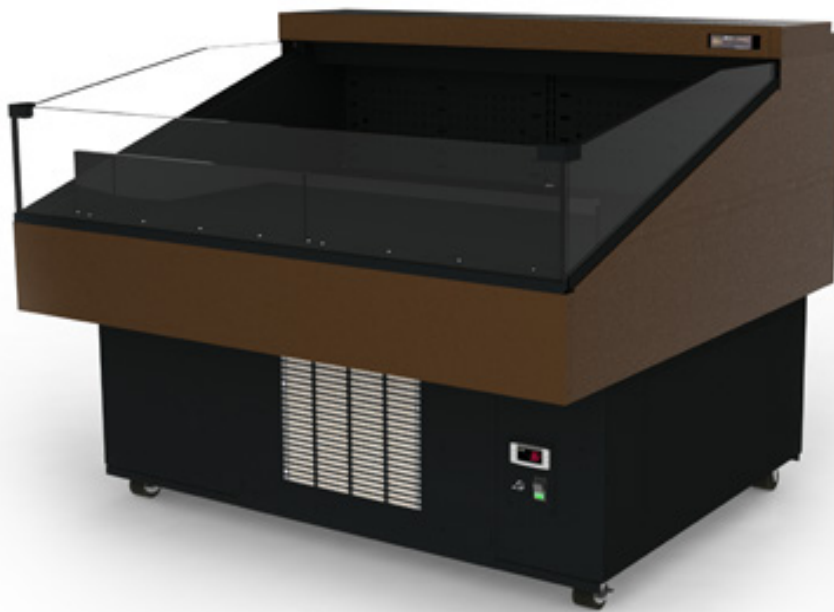

140 Park Street • Milo, Maine 04463 • 800.332.5507 TEL • 207.943.5632 FAX • JSISTOREFIXTURES.COM
Milo, Maine • Bangor, Maine • Payson, Utah • Greenville, South Carolina • Collingwood, Ontario

4'X4' LOW BACK REFRIGERATED SLANT BIN

DESCRIPTION

JSI's critical temp Refrigerated Slant Bins are available in our full range of styles and finish options to perfectly match your entire department. The low front design allows for maximum product visibility and a variety of merchandising options.

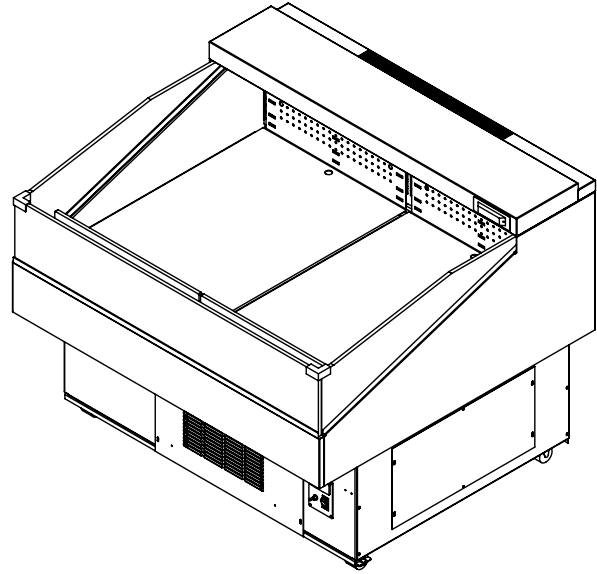

FEATURES



Electronic Controls

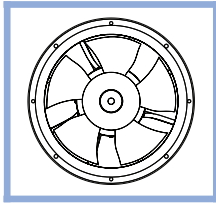

High-Efficiency Fan Motors

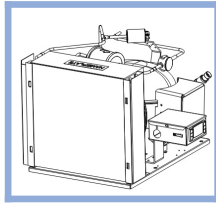

High-Efficiency Condensing Unit



Intertek Intertek

STANDARD FEATURES

- High Efficiency Motors
- Digital Solar Thermometer
- Removable Service Panels
- Electronic Control
- Designed to Maintain Product Temperatures at <41°F
- ETL Listed
- Electric Condensate Pan

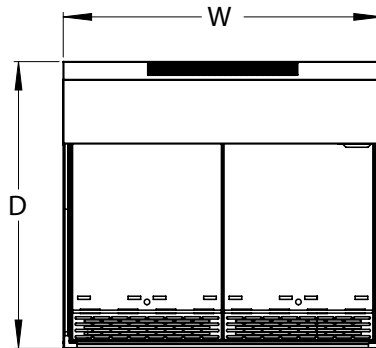

OPTIONAL ACCESSORIES

- Merchandising Steps
- Extendable Shelf
- Corner Guards and Brackets
- Adjustable Wire Rack
- Foam Pan
- Price Tag Molding
- Tilt Pan
- Magnetic Filter Screen

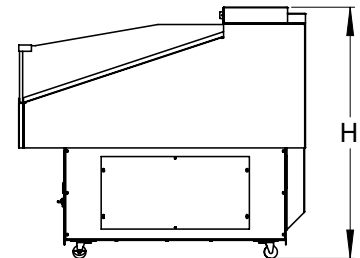
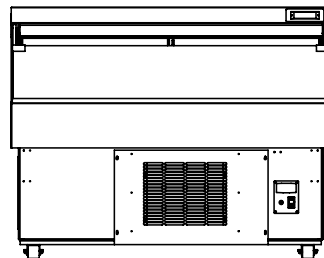

W x D x H				POWER						
MODEL	Brunswick	Sebago	Baxter	V	Ph	Hz	AMPS	FUSE SIZE	HP	BTU/hr @ 90F
RBS044L	53" X 46" X 40"	53" X 46" X 40"	53" X 47" X 40"	115	1	60	20.1	20	½	4750

MATERIALS, FINISHES, FOAM, AND ACCESSORIES

Please refer to our "Styles, Groupings, Stains and Accessories" brochure to see our wide range of materials, finishes, merchandising foam, and accessories.